

Mechanical structure

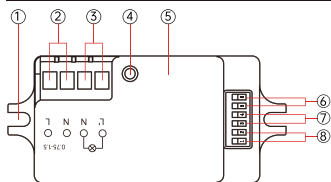

- ① Installation Hole
- ② Input
- ③ Output
- ④ Daylight Sensor
- ⑤ Microwave Module
- ⑥ Daylight Threshold
- ⑦ Hold Time
- ⑧ Detection Area

Wiring Diagram

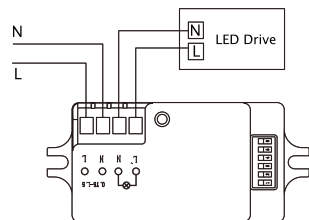

Detection Patterns

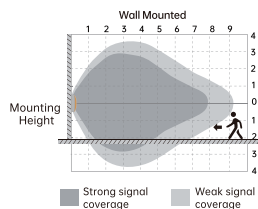
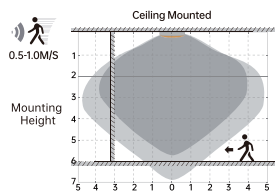

Highest mounting height is 6m
This figure indicates the maximum distance at the highest mounting height with 100% sensitivity.

Dial code setting

Switch UP	5 6	• Disable	Definition of the ambient brightness; only when the ambient brightness is lower than the preset specific lux amount, the sensor will work; when it's preset as "disable", the sensor works everytime it detects motion regardless the ambient brightness.
Switch DOWN	• 50lux		
	• 10lux		
	• 2lux		
Daylight threshold	3 4	• 5s	The period of light keeping 100% brightness after moving objects leave the detection area.
	• 90s		
	• 5min		
	• 15min		
Hold-time	1 2	• 100%	In this area, movement will be detected and able to trigger the sensor. 100% detection area is also known as the strong sensitivity.
	• 75%		
	• 50%		
	• 10%		
Detection area			

Performance

1. Automatically ON/OFF function



With sufficient daylight, even when motion detected, light remains OFF.



With insufficient daylight, the sensor turns light ON when motion gets detected.

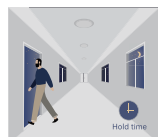

The sensor turns OFF light automatically after the holdtime when there's no motion detected.

2. Daylight Disable

When daylight threshold is preset as "disable", the sensor turns light ON when motion gets detected, and OFF after hold-time.

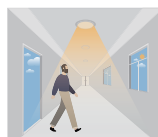

The sensor turns light ON when motion gets detected.



The sensor keeps light ON for holdtime period after motion leaves.

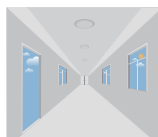

The sensor turns OFF light automatically after the holdtime.

ART. NO.

102471-105-3
102471-MW-105-3
102472-105-3
102472-MW-105-3
102472-105-3-ddd

102473-105-3
102473-MW-105-3
102473-105-3-ddd

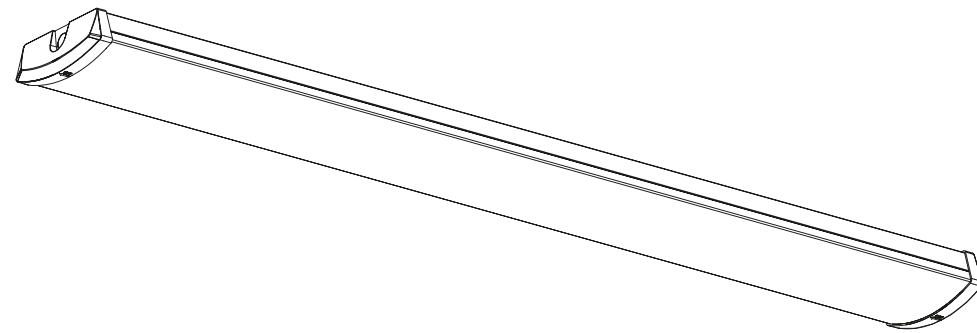

Universal G2

INSTALLATION MANUAL



⚠ Safety Notes:

- The product must be installed, maintained, and operated as instructions below.
- Before starting installation of this product, make sure power supply is disconnected.
- Only to be installed by authorized electrician.
- Do not use abrasives or solvents when cleaning.
- Do not install the product if it appears damaged in any way. Check with manufacturer if in doubt.
- Do not modify this fitting in any matter as this will void warranty.
- Check protection class, if class I, it must be earthed.
- Disconnect power supply before maintenance or cleaning.
-

⚠ Sikkerhetsinformasjon:

- Følg installasjonsmanual for korrekt montering.
- Koble alltid fra strømmen før montering eller vedlikehold.
- Kan kun monteres av autorisert elektriker.
- Monter ikke produktet hvis det er synlig skade. Kontakt forhandler eller produsent.
- Bruk ikke løsemidler ved rengjøring
- Produktet skal ikke under noen omstendigheter endres eller modifiseres.
- Sjekk produktets isolasjonsklasse. Ved isolasjonsklasse I skal produktet jordes.

Imported by Norlux AS | Borgeskogen 32, 3160 Stokke, Norway | norlux.com

